

INSTRUCTION MANUAL

LKG 601

Electrical Safety Analyzer



110 Toledo Street • Farmingdale, NY 11735 • USA

<http://www.Netech.org>

Dear User,

We appreciate your purchase of the LKG 601 Electrical Safety Analyzer. Properly used, the LKG 601 will deliver years of high performance and accuracy.

This instruction manual has been designed as a tool to assist you in getting the most from your LKG 601. In order to properly use and to maintain this instrument, please read the manual carefully.

Netech is recognized as an innovative designer and manufacturer of advanced biomedical and industrial test instruments. We are ISO 9001-2000 Certified and fully committed to a continuous improvement process. Further, we guarantee absolute satisfaction with our products.

Your business is important to us and we are dedicated to providing you with the best customer and technical service possible. Please contact us should you have any questions or concerns regarding your instrument.

We hope you will consider us again when you have a requirement for accurate, reliable, affordable test instruments.

Sincerely,

NETECH CORPORATION

Innovative Biomedical Test Instruments

Copyright

Copyright © 2002 by Netech Corporation. All rights reserved. No part of this publication may be reproduced or transmitted in any form other than for the purchaser's personal use without written permission from Netech Corporation.

Quality Assurance

Netech Corporation is ISO 9001-2000 Certified. This instrument was thoroughly tested and inspected according to Netech's ISO 9001-2000 quality standards and test procedures, and was found to meet those specifications when it was shipped from the factory.

Warranty

Netech warrants the LKG 601 against defects in materials and workmanship for one year from the date of original purchase. **The standard warranty is extended for a second year if the instrument is returned to Netech for its recommended yearly recalibration.**

During the warranty period, we will repair or, at our option, replace at no charge a product that proves to be defective, provided you return the product shipping prepaid to Netech Corporation. This warranty does not apply if the product has been damaged by accident or misuse, or as the result of service or modification by other than Netech Corporation, or if its serial number is defaced or removed.

Netech reserves the right to discontinue the LKG 601 at any time, and change its specifications, price, or design without notice and without incurring any obligation. Netech guarantees availability of service parts for 5 years after the manufacture of the unit is discontinued.

The warranty is void if you elect to have the unit serviced and / or calibrated by someone other than Netech.

The purchaser assumes all liability for any damages or bodily injury that may result from the use or misuse of the unit by the purchaser, his employees, agents or customers.

In no event shall Netech Corporation be liable for consequential damages

Trademarks

Netech and **LKG 601** are trademarks of Netech Corporation. Any other trademark names used in this manual are only for editorial purposes and the benefit of the respective trademark owner, with no intention of improperly using that trademark.

Safety Considerations

General

Before operation, the instrument and related documentation must be reviewed for familiarization with all safety markings and instructions

Safety Symbols

WARNING

The “***WARNING***” sign denotes a hazard. It calls attention to a procedure, practice or the like, which, if not correctly performed or adhered to, could result in personal injury. Do not proceed beyond a “***WARNING***” sign until the indicated conditions are fully understood and met.

CAUTION

The “***CAUTION***” sign denotes a hazard. It calls attention to a procedure, practice or the like, which, if not correctly performed or adhered to, could result in damage to or destruction of part or the entire instrument. Do not proceed beyond a “***CAUTION***” sign until the indicated conditions are fully understood and met.



The symbol to the left is the operator’s manual symbol. When you see this symbol on the instrument, refer to the operator’s manual.

TABLE OF CONTENTS

General Description	7
Controls and Indicators	9
Preparation for use	11
Operating Instructions	12
Maintenance	16
Theory of Operation	17
Specifications	19
Instructions for Return	21

LIST OF FIGURES

Figure 1	Front view-LKG 601	8
Figure 2	Block Diagram, Cord Resistance and Case Leakage Measurements	12
Figure 3	Functional Block Diagram	17

GENERAL DESCRIPTION

The LKG 601 is a compact, low cost Electrical Safety Analyzer designed to evaluate the basic electrical safety of all electrical systems including medical devices and physiological instrumentation.

The LKG 601 measures Electrical Leakage Current, Power Cord Ground Resistance, and Device Current.

The LKG 601 is simple to operate. A three-position switch selects the test to be performed. The user may select either the AAMI ESI-1993 or the IEC 601-1 test load to compensate for high frequency components in the measurement.

Accurate resistance measurements are made via a simple method using a single conductor cable. No special cables are required. A calibrated output is provided through a test jack to verify the performance of the LKG 601.

Key Features

- Compact.
- Easy to Use.
- Measures:
 - Device Current
 - Cord (Ground) Resistance
 - Ground Leakage Current
 - Case (Chassis) Leakage Current
- Test Jack for Calibrated Outputs.
- True RMS Measurement.
- AAMI or IEC 601 Test Load Selector.

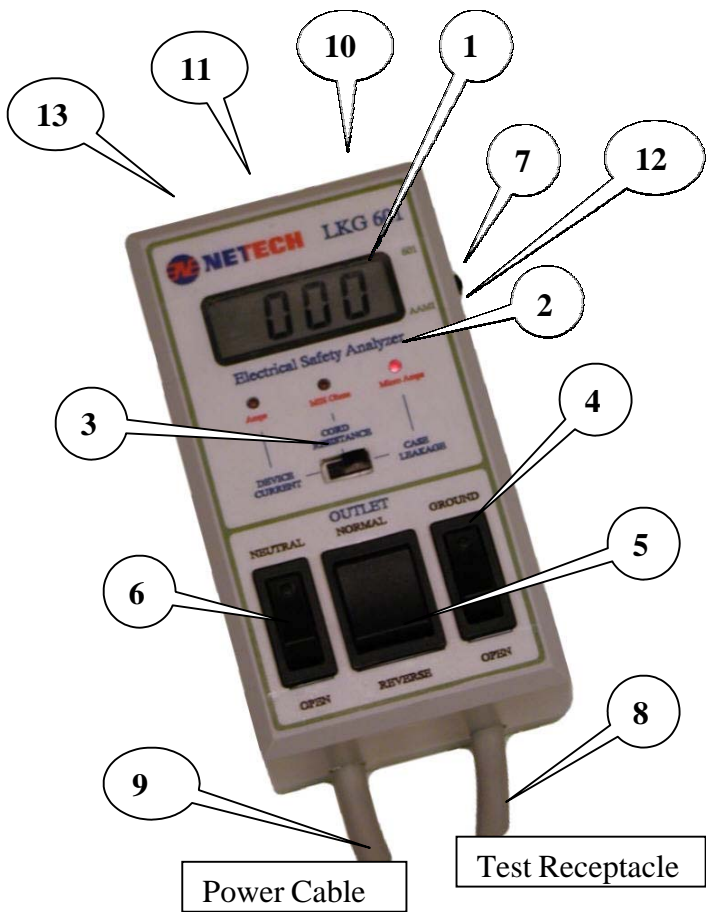

Figure 1
Front view of the LKG 601

CONTROLS AND INDICATORS

1. **DISPLAY:** A 3½ Digit LCD indicates the result of the measurement being made.
2. **LEDS:** 3 red LEDES indicate the selected test mode.
3. **MODE SWITCH:** Three-position slide switch to select the test measurement. A lit red LED indicates the selection.
4. **GROUND SWITCH:** A switch to momentarily open the ground connection to the test receptacle.
5. **POLARITY SWITCH:** A three-position switch to select the normal and reverse polarity of the test receptacle. The center position shuts the power off to the test receptacle.
6. **NEUTRAL SWITCH:** A switch to momentarily open the neutral line to the test receptacle.
7. **LOAD SELECTOR SWITCH:** A slide switch on the right side of the instrument to select either the AAMI or the IEC 601-1 test load.
8. **TEST RECEPTACLE:** A 20 AMP power receptacle for the Device Under Test.
9. **POWER CORD:** The power cord supplies power to the analyzer and to the Device Under Test.

- 10. CASE GROUND:** A red jack is provided for connecting the test lead to the case (chassis) of the Device Under Test. The Cord Resistance and Case Leakage are measured using this cable.
- 11. TEST JACKS:** A calibrated output is provided at the test jack for resistance and current functions. This performs a self-check of the LKG 601.
- 12. ZERO ADJUSTMENT:** This recessed adjustment allows for the zeroing of the display to eliminate test cable resistance variations.
- 13. FUSE:** 15 Ampere fuse is in an accessible fuse holder for 110 Volt model. The 230 Volt model uses a 10-Ampere fuse.

PREPARATION FOR USE

The LKG 601 includes a test lead for measuring Cord Resistance and Case Leakage. No other cables are required to perform measurements. Connect the LKG 601 to a 110 VAC outlet (Or 220 VAC for 220-Volt Units).

Before proceeding with any measurement become familiar with the measurements and the function selector switch.

During the initial setup the last digit of the LCD will change gradually due to the time constant of the RMS to DC converter. The display will stabilize to zero in a few seconds.

CAUTION

Make sure that the power requirements of the Device Under Test are within the power ratings of the LKG 601, 15 amps at 110 volts and 10 amps at 230 volts.

CAUTION

Do not leave the Device Under Test continuously turned on and connected to the LKG601.

OPERATING INSTRUCTIONS

1. CORD RESISTANCE MEASUREMENT:

See Figure 2.

- Set the polarity switch to the off (center) position.
- Move the MODE switch to CORD RESISTANCE. Plug the Device Under Test into the test outlet.
- Using the test lead provided, connect the chassis of the Device Under Test to the Case Ground jack on the LKG 601.
- The display will indicate the Power Cord Resistance in milliohms.

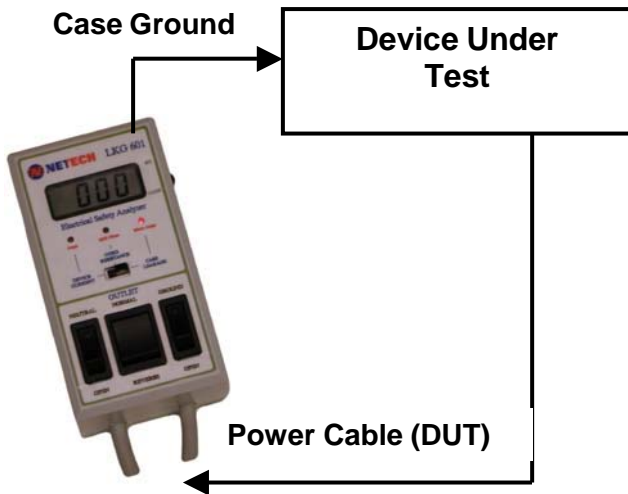

Figure 2

Block Diagram for Cord Resistance measurement and Case Leakage measurement (external).

2. CASE LEAKAGE CURRENT MEASUREMENTS:

Move the Mode switch to CASE LEAKAGE.

See Figure 2. The Earth Leakage (or Ground Leakage) Current is measured through the ground conductor of the Device Under Test. This is only applicable to devices with a three- conductor power cord.

The leakage measurement is made internally when the Ground switch is momentarily opened. The LCD will display the measurement in Micro Amps. There is no other connection required.

To measure the Case Leakage of devices with plastic enclosures, wrap aluminum foil around the case and connect the test lead to the foil.

The Case Leakage Current is measured through the test lead cable. Connect the test Lead to the case of the DUT(Device under test). The leakage measurement is made when the Ground switch is momentarily opened. The LCD will display the measurement in Micro Amps.

Both Earth and Case Leakage Current measurements should be made in all power switch combinations with the Polarity switch in Normal and Reverse, and the Neutral switch Open and with the DUT On and Off.

CAUTION

When switching from Normal to Reverse or vice versa, make sure to pause the rocker switch in the off (middle position). Power to the outlet will be OFF in the open neutral position.

3. DEVICE CURRENT MEASUREMENT:

Move the Mode switch to DEVICE CURRENT. Set the polarity switch to normal. Turn the DUT On. The LCD will display the Device Current in Amps.

CAUTION

Do not attempt to open the unit. There are no user serviceable parts inside. Further, the warranty will be void if the unit is opened by other than Netech trained personnel.

PERFORMANCE CHECK

1. Connect the LKG 601 to a live 110 VAC (or 220 VAC for the LKG 601-220) outlet. Display will turn on and read 0 ± 1 when the Mode switch is in the Case Leakage position. In the CORD RESISTANCE position the display will show the numeral one (1) in the left position indicating that the cord circuit is open.

2. Move the Mode selector switch to all three positions and test the LED indication.
3. Check the continuity between receptacle ground and case ground using the test cable. If necessary adjust the display to zero. When the open ground switch is pressed down the connection will be open.
4. Connect the Test Lead to the TEST JACK. Move the selector switch to CORD RESISTANCE. The reading should be 1010 milliohms \pm 5%.
5. Move the switch to CASE LEAKAGE. The display will indicate 200 Micro Amps \pm 2%.

These tests will confirm that the LKG 601 is working properly.

MAINTENANCE

The LKG 601 requires only minimum maintenance.

Periodically check the inlet plug, outlet receptacle, and wiring for any damage or wear like cracks, cuts, or other defects. Also check the case for any damage or cracks.

In order to ensure the accuracy, it is recommended that the unit be checked periodically. A calibrated output is provided at the TEST JACK for Case Leakage and Cord Resistance functions. This feature is useful to check the integrity of the unit.

When making a resistance measurement with a Test Cable other than the one supplied with the LKG 601, the user can zero the leads by adjusting the zero adjustment potentiometer. This will not affect the internal calibration of the unit.

Annual calibration is recommended. If the LKG 601 is returned to Netech for recalibration before the first year warranty expires Netech will provide a second year warranty. The warranty is void if the LKG 601 is serviced by anyone other than Netech or if the warranty seal is broken.

THEORY OF OPERATION

The LKG 601 circuitry can be divided into main functional blocks as shown in Figure 3. Each performs a key role in the operation of the instrument.

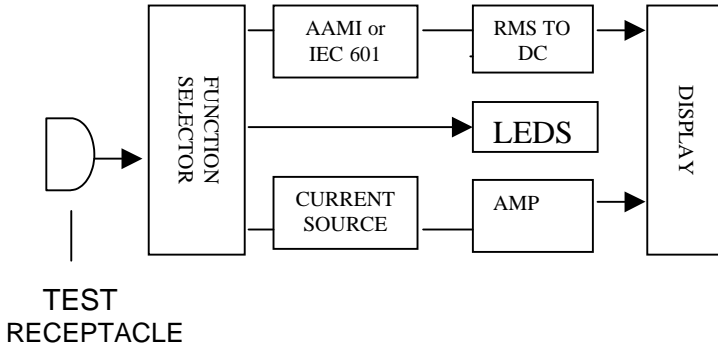

Figure 3

Functional block diagram of the LKG 601.

BLOCK DIAGRAM DESCRIPTION

Test Load: The input test load is user selectable to AAMI ESI –1993 or to IEC 601.

RMS Converter and Amplifier: The input amplifier buffers the input. The RMS converter generates a DC voltage equal to the RMS value at its input. The gain Amplifier sets the gain for the measurements. When the MODE switch selects leakage current measurement, the AAMI LOAD is connected in front of the INPUT AMPLIFIER, and the voltage developed across it from the leakage current is measured.

Current Source and Amplifier: Resistance is measured by connecting the current source to the resistance to be measured and measuring the voltage with the input amplifier.

Test Receptacle: This supplies power to the unit under test, 110 VAC rated at 15 Amps (220 VAC). The rocker polarity switch selects NORMAL, OFF and REVERSES polarity in the test receptacle.

Display: All measurements are displayed on a 3-1/2 digit LED display. Over range is indicated by showing a 1 in the most significant digit.

SPECIFICATION

S METER: 3-1/2 Digit LED

display.

LEAKAGE CURRENT: 0-1999 Micro Amps.
All Current measurements are made through the AAMI/ANSI ES1-1985 or IEC 601-1 test load. The meter readings correspond to the true RMS value of the current.

Accuracy: $\pm 1\%$ of reading, ± 1
LSD DC to 1 KHz,
 $\pm 2.5\%$ of reading ± 1 LSD
1 KHz to 100 KHz,
 $\pm 5\%$ of reading ± 1 LSD
100 KHz to 1 MHz,

RESISTANCE: 0 TO 1999 Milli Ohms.

Accuracy: $\pm 1\%$ of reading ± 1 LSD

DEVICE CURRENT: 0 to 19.99 Amps

Accuracy: $\pm 2\%$ Full Scale ± 1 LSD

TEST RECEPTACLE: Hospital Grade 110 VAC
-15 Amp or 220 VAC 10 Amp.

The rocker polarity switch selects NORMAL, OFF and REVERSE Polarity to the test receptacle, and a momentary Neutral switch will open the neutral line to the test receptacle.

POWER REQUIREMENTS: 110 VAC 50-60Hz,
15 Amps or 220 VAC, 10 Amps maximum rated for the test outlet and 0.1 Amp rated for the unit.

PHYSICAL DIMENSIONS:

Size: 5.5x 3.25 x 2.5 Inches

Weight: 1 lbs (.45kg)

ENVIRONMENTAL:

Operating range: 59 to 95⁰ F (15 to 40⁰ C)

Storage Temperature: 0 to 122⁰ F (-20 to 60⁰ C)

Relative Humidity: 90% (max) at temperatures

STANDARD ACCESSORIES:

Description	Part Number
User Manual	510-MANUAL
Test Cable	503

OPTIONAL ACCESSORIES:

Description	Part Number
Soft Carrying Case	510-Case

INSTRUCTIONS FOR RETURN

Damaged in Transit:

All shipments are carefully examined by NETECH and carefully packaged for shipment. They are insured in the customer's name with the carrier. On receipt, if the shipping container appears to have been damaged during shipment, the instrument should be thoroughly inspected.

The delivering carrier's paper should be signed noting the apparent damage. If the instrument is damaged beyond use, a new order should be placed with NETECH while awaiting reimbursement from the carrier for the damaged instruments.

Malfunction:

Please follow these steps for the repair or recalibration of your NETECH instrument:

1. Obtain a Service /Repair Form from our website at

www.Netech.org

Or from

Customer Service Department

Phone: 631-531-0100.

Fax: 631-531-0101

Toll Free: 800-547-6557

2. Complete the Service Form indicating the instrument's model number, serial number, shipping, and billing information. Include the purchase order number or credit card information for the cost of the repair and/or recalibration.
3. Securely package your instrument in a strong box, surrounded by at least two inches of suitable shock absorbing material.
4. Include a copy of the purchase order, or reference your purchase order on your packing slip.
5. Include the completed Service Form.
6. Ship the instrument to the following address:

**NETECH CORPORATION
110 Toledo Street
Farmingdale, NY 11735
ATTN: SERVICE DEPT.**

**For the latest Revisions and updates visit
www.netech.org**

LKG 601 Quick check for Resistance and Leakage functions.

TOP PANEL CONNECTORS

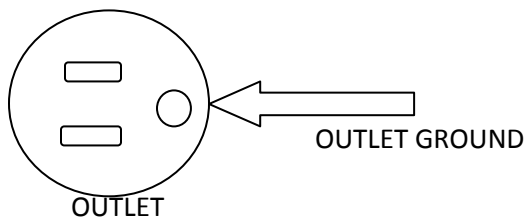
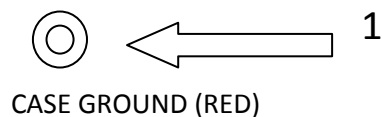
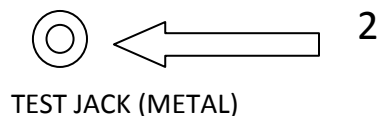
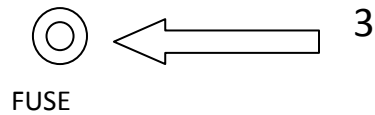

1-Connect 503 cable between CASE GROUND (RED) to TEST JACK (METAL).(Between 1 to 2).Select CASE LKG , Display will read between 197 to 203.

2-Connect 503 cable between CASE GROUND and TEST JACK . (Between 1 to 2). Select CORD RESISTANCE . Display will read 1050-1100 Approximately. This will include the total resistance of 1000 milliohms (internal resistor)+ Lead resistance which is typically 20 to 80 milliohms..

3-Connect 503 cable between CASE GROUND to Outlet GROUND.(Between 1 to OUTLET GROUND). CORD RESISTANCE selected. Display will read 0000.If not Zero it by using a small Phillips screwdriver. Turn the screw located on the RIGHT side of LKG601. It is Located next to the test load selector switch.